

# Form 38

ca. 149 x 83 mm

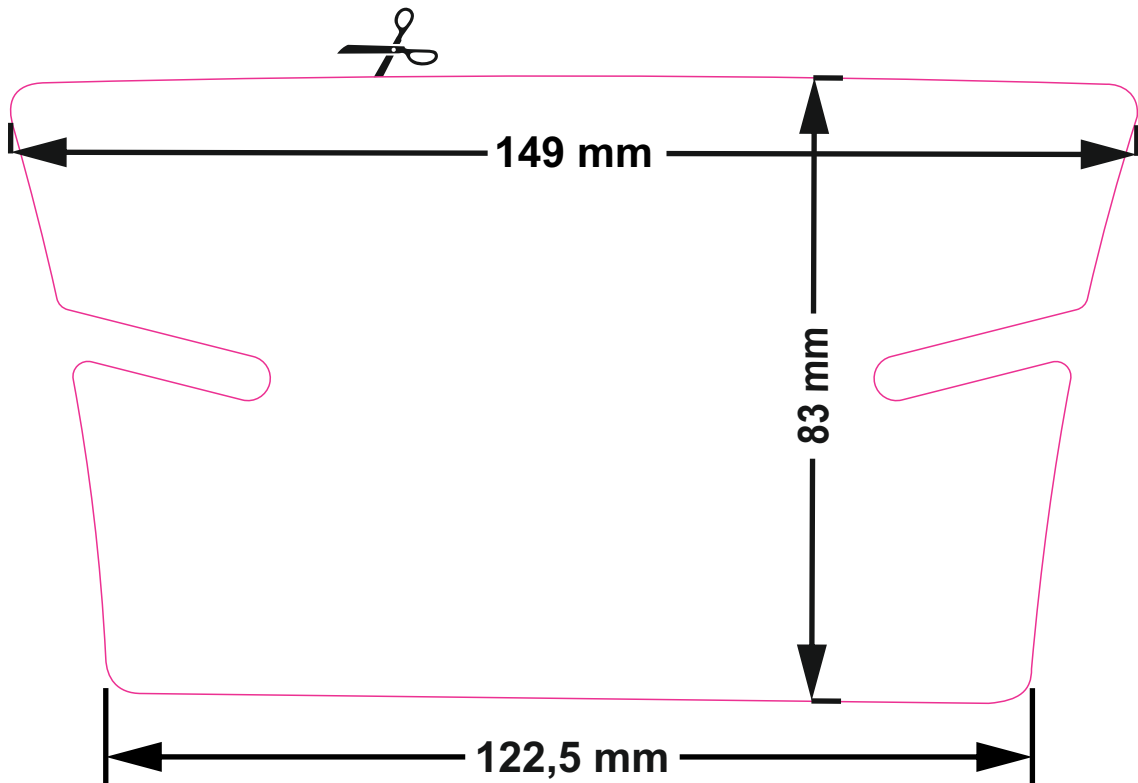

M 1:1



Hier Lineal anlegen

1cm 2cm 3cm



Datei downloaden



ausdrucken



anhand des Maßstabs die korrekte Größe prüfen



entlang der Linie ausschneiden



passgenauigkeit an der Maschine überprüfen

**Tankpad-Form**  
zum ausdrucken und ausschneiden