

Form 25

ca. 187 x 220 mm

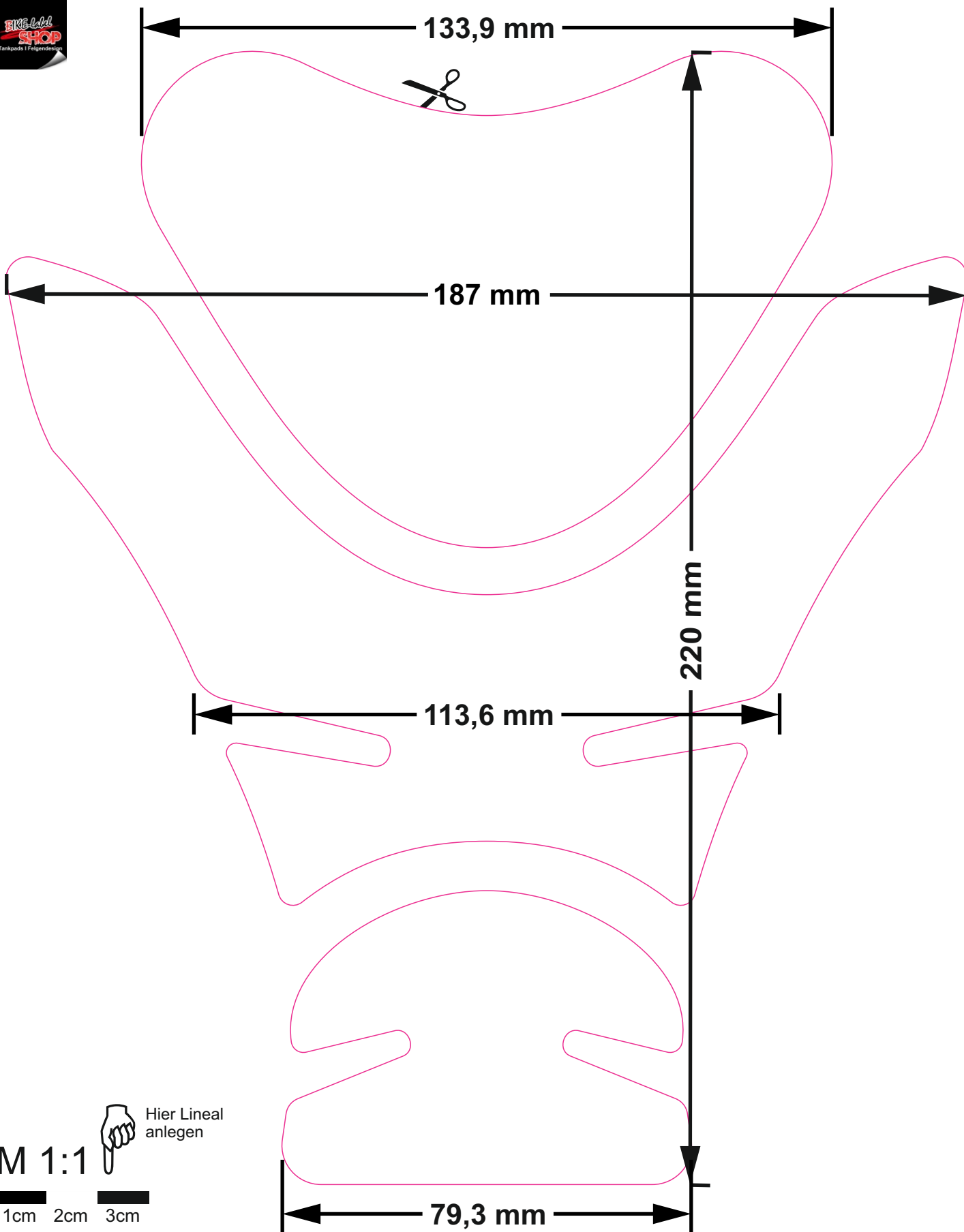

M 1:1



Hier Lineal anlegen

1cm 2cm 3cm



Datei downloaden



ausdrucken



anhand des Maßstabs die korrekte Größe prüfen



entlang der Linie ausschneiden



passgenauigkeit an der Maschine überprüfen

Tankpad-Form

zum ausdrucken und ausschneiden